

MC74

Serial Digital Temperature Sensor

The MC74 is a serial digital temperature sensor suited for low cost applications. Temperature data is converted from the integrated thermal sensing element and made available as an 8-bit serial digital word. Communication with the MC74 is accomplished via 2-wire SMBus/I²C-compatible serial port. Temperature resolution is 1°C. Conversion rate is a nominal 8 samples/sec. Power consumption is only 200 µA (5.0 µA Standby).

Features

- Temperature Range: -40°C to +125°C
- Outputs Temperature as an 8-Bit Digital Word
- Simple Serial Port Interface
- Solid State Temperature Sensing:
 - ±2°C Accuracy from +25°C to +85°C
 - ±3°C Accuracy from 0°C to +125°C
- 3.3 V and 5.5 V Operating Range
- Low Power
 - 200 µA Operations
 - 5.0 µA Standby Mode

Typical Applications

- Thermal Protection for Hard Disk Drives and Other PC Peripherals
- Low-Cost Thermostat Controls
- Power Supplies

FUNCTIONAL BLOCK DIAGRAM

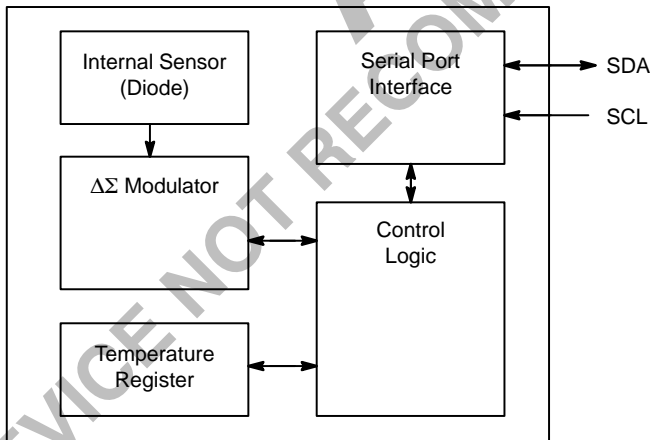

ON Semiconductor™

<http://onsemi.com>

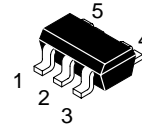

SOT-23
SN SUFFIX
CASE 1212

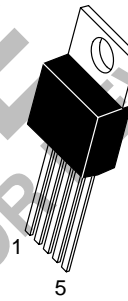

TO-220
T SUFFIX
CASE 314D

PIN CONNECTIONS

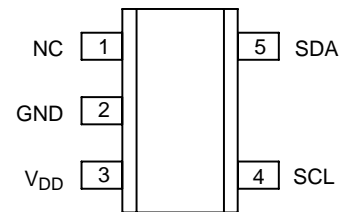

(Top View)

SOT-23A*

NOTE: *SOT-23A is equivalent to EIAJ-SC74A

ORDERING INFORMATION

See detailed ordering and shipping information on page 9 of this data sheet.

DEVICE MARKING INFORMATION

See general marking information in the device marking section on page 9 of this data sheet.

MC74

PIN DESCRIPTION FOR TO-220-5

Pin No.	Symbol	Type	Description
1	NC	None	Not Connected
2	SDA	Bi-directional	SMBus Serial Data
3	GND	Power	System Ground
4	SCL	Input	SMBus Serial Clock
5	V _{DD}	Power	Power Supply Input

PIN DESCRIPTION FOR SOT-23-5

Pin No.	Symbol	Type	Description
1	NC	None	Not Connected
2	GND	Power	System Ground
3	V _{DD}	Power	Power Supply Input
4	SCL	Input	SMBus Serial Clock
5	SDA	Bi-directional	SMBus Serial Data

PIN DESCRIPTION

SCL

SMBus Serial Clock Input. Clocks data into and out of the MC74. See System Management Bus Specification, rev. 1.0, for timing diagrams.

V_{DD}

Power Supply Input. See electrical specifications.

GND

Ground return for all MC74 functions.

SDA

Bi-directional Input/Output. Serial data is transferred on the SMBus in both directions using this pin. See System Management Bus Specification rev. 1.0 for timing diagrams.

ABSOLUTE MAXIMUM RATINGS*

Rating	Symbol	Value	Unit
Power Supply Voltage	V _{DD}	6.0	V
Voltage on Any Pin	–	(GND –0.3 V) to (V _{DD} +0.3 V)	V
Operating Temperature Range	T _A	–40 to +125	°C
Storage Temperature Range	T _{stg}	–65 to +150	°C
Current on Any Pin	–	±50	mA
Package Thermal Resistance	R _{θJA}	330	°C/W

*Maximum Ratings are those values beyond which damage to the device may occur.

*Static-sensitive device. Unused devices must be stored in conductive material. Protect devices from static discharge and static fields. Stresses above those listed under Absolute Maximum Ratings may cause permanent damage to the device. These are stress ratings only and functional operation of the device at these or any other conditions above those indicated in the operational sections of the specifications is not implied. Exposure to Absolute Maximum Rating Conditions for extended periods may affect device reliability.

MC74

DC ELECTRICAL CHARACTERISTICS ($V_{DD} = 3.3\text{ V}$ or 5.0 V (Note 5.), $-40^{\circ}\text{C} \leq T_A \leq 125^{\circ}\text{C}$, unless otherwise noted.)

Characteristic	Symbol	Min	Typ	Max	Unit
Power Supply					
Power-On Reset Threshold (V_{DD} Falling Edge or Rising Edge)	V_{POR}	1.2	–	2.2	V
Operating Current ($V_{DD} = 5.5\text{ V}$, Serial Port Inactive) (Note 1.)	I_{DD}	–	200	350	μA
Standby Supply Current ($V_{DD} = 3.3\text{ V}$, Serial Port Inactive) (Note 4.)	$I_{DD\text{-STANDBY}}$	–	5.0	10	μA

Temperature-to-Bits Converter

Temperature Accuracy MC74A $+25^{\circ}\text{C} \leq T_A \leq +85^{\circ}\text{C}$ $0^{\circ}\text{C} \leq T_A \leq +125^{\circ}\text{C}$ $-40^{\circ}\text{C} \leq T_A \leq 0^{\circ}\text{C}$	T_{ERR}	–2.0 –3.0 –	– – ± 2.0	+2.0 +3.0 –	$^{\circ}\text{C}$
Conversion Rate (Note 2.)	CR	4.0	8.0	–	sa/sec

Serial Port Interface

Logic Input High	V_{IH}	$0.8 \times V_{DD}$	–	–	V
Logic Input Low	V_{IL}	–	–	$0.2 \times V_{DD}$	V
SDA Output Low $I_{OL} = 3\text{ mA}$ (Note 3.) $I_{OL} = 6\text{ mA}$ (Note 3.)	V_{OL}	– –	– –	0.4 0.6	V
Input Capacitance SDA, SCL	C_{IN}	–	5.0	–	pF
I/O Leakage	I_{LEAK}	–1.0	0.1	1.0	μA

SERIAL PORT AC TIMING ($V_{DD} = 3.3\text{ V}$ or 5.0 V (Note 5.), $-40^{\circ}\text{C} \leq (T_A = T_J) \leq 125^{\circ}\text{C}$; $C_L = 80\text{ pF}$ unless otherwise noted.)

Characteristic	Symbol	Min	Typ	Max	Unit
SMBus Clock Frequency	f_{SMB}	10	–	100	kHz
Low Clock Period (10% to 10%)	t_{LOW}	4.7	–	–	μsec
High Clock Period (90% to 90%)	t_{HIGH}	4.0	–	–	μsec
SMBus Rise Time (10% to 90%)	t_R	–	–	1,000	nsec
SMBus Fall Time (90% to 10%)	t_F	–	–	300	nsec
Start Condition Setup Time (90% SCL to 10% SDA) (for Repeated Start Condition)	$t_{SU(START)}$	4.0	–	–	μsec
Start Condition Hold Time	$t_{H(START)}$	4.0	–	–	μsec
Data in Setup Time	$t_{SU-DATA}$	1,000	–	–	nsec
Data in Hold Time	t_{H-DATA}	1,250	–	–	nsec
Stop Condition Setup Time	$t_{SU(STOP)}$	4.0	–	–	μsec
Bus Free Time Prior to New Transition	t_{IDLE}	4.7	–	–	μsec
Power-On Reset Delay ($V_{DD} \geq V_{POR}$ (Rising Edge))	t_{POR}	–	500	–	μsec

- Operating current is an average value integrated over multiple conversion cycles. Transient current may exceed this specification.
- Maximum guaranteed conversion time after Power-On RESET (POR to DATA_RDY) is 250 msec.
- Output current should be minimized for best temperature accuracy. Power dissipation within the MC74 will cause self-heating and temperature drift error.
- SDA and SCL must be connected to V_{DD} or GND.
- $V_{DD} = 3.3\text{ V}$ for MC74–33SNTR. $V_{DD} = 5.0\text{ V}$ for MC74–50T. All part types of the MC74 will operate properly over the wider power supply range of 2.7 V to 5.5 V. Each part type is tested and specified for rated accuracy at its nominal supply voltage. As V_{DD} varies from the nominal value, accuracy will degrade $1^{\circ}\text{C}/\text{V}$ of V_{DD} change.

DETAILED OPERATING DESCRIPTION

The MC74 acquires and converts temperature information from its integrated solid state sensor with a basic accuracy of $\pm 1^{\circ}\text{C}$. It stores the data in an internal register which is read through the serial port. The system interface is a slave SMBus. The temperature data can be read at any time through the SMBus port. Eight SMBus addresses are programmable for the MC74, which allows for a multi-sensor configuration. Also, there is low-power Standby mode where temperature acquisition is suspended.

Standby Mode

The MC74 allows the host to put it into a low power ($I_{DD} = 5.0 \mu\text{A}$, typical) Standby mode. In this mode, the A/D converter is halted and the temperature data registers are frozen. The SMBus port operates normally. Standby mode is enabled by setting the SHDN bit in the CONFIG register. The table below summarizes this operation.

Standby Mode Operation

SHDN Bit	Operating Mode
0	Normal
1	Standby

SMBus Slave Address

The MC74 is internally programmed to have a default SMBus address value of 1001 101b. Seven other addresses are available by custom order (contact factory).

SERIAL PORT OPERATION

The Serial Clock input (SCL) and bi-directional data port (SDA) form a 2-wire bi-directional serial port for programming and interrogating the MC74. The following conventions are used in this bus architecture:

MC74 Serial Bus Conventions

Term	Explanation
Transmitter	The device sending data to the bus.
Receiver	The device receiving data from the bus.
Master	The device which controls the bus: initiating transfers (START), generating the clock, and terminating transfers (STOP).
Slave	The device addressed by the master.
Start	A unique condition signaling the beginning of a transfer indicated by SDA falling (High-Low) while SCL is high.
Stop	A unique condition signaling the end of a transfer indicated by SDA rising (Low-High) while SCL is high.
ACK	A receiver acknowledges the receipt of each byte with this unique condition. The receiver drives SDA low during SCL high of the ACK clock-pulse. The Master provides the clock pulse for the ACK cycle.
Busy	Communication is not possible because the bus is in use.
NOT Busy	When the bus is idle, both SDA and SCL will remain high.
Data Valid	The state of SDA must remain stable during the High period of SCL in order for a data bit to be considered valid. SDA only changes state while SCL is low during normal data transfers (see Start and Stop conditions).

All transfers take place under control of a host, usually a CPU or microcontroller, acting as the Master which provides the clock signal for all transfers. The MC74 *always* operates as a Slave. The serial protocol is illustrated in Figure 1. All data transfers have two phases; all bytes are transferred MSB first. Accesses are initiated by a start condition (START), followed by a device address byte and one or more data bytes. The device address byte includes a Read/Write selection bit. Each access must be terminated by a Stop Condition (STOP). A convention called *Acknowledge* (ACK) confirms receipt of each byte. Note that SDA can change only during periods when SCL is LOW (SDA changes while SCL is HIGH are reserved for Start and Stop Conditions).

MC74

Write Byte Format

S	ADDRESS	WR	ACK	COMMAND	ACK	DATA	ACK	P
	7 Bits			8 Bits		8 Bits		

Slave Address

Command Byte: selects which register you are writing to.

Data Byte: data goes into the register set by the command byte.

Read Byte Format

S	ADDRESS	WR	ACK	COMMAND	ACK	S	ADDRESS	RD	ACK	DATA	NACK	P
	7 Bits			8 Bits			7 Bits			8 Bits		

Slave Address

Command Byte: selects which register you are reading from.

Slave Address: repeated due to change in data-flow direction.

Data Byte: reads from the register set by the command byte.

Receive Byte Format

S	ADDRESS	RD	ACK	DATA	NACK	P
	7 Bits			8 Bits		

Data Byte: reads data from the register commanded by the last Read Byte or Write Byte transmission.

S = Start Condition
P = Stop Condition
Shaded = Slave Transmission

Figure 1. SMBus Protocols

Start Condition (START)

The MC74 continuously monitors the SDA and SCL lines for a start condition (a HIGH to LOW transition of SDA while SCL is HIGH) and will not respond until this condition is met.

Address Byte

Immediately following the Start Condition, the host must transmit the address byte to the MC74. The states of A1 and A0 determine the 7-bit SMBus address for the MC74. The 7-bit address transmitted in the serial bit stream must match for the MC74 to respond with an Acknowledge (indicating the MC74 is on the bus and ready to accept data). The eighth bit in the Address Byte is a Read-Write Bit. This bit is a 1 for a read operation or 0 for a write operation. During the first phase of any transfer this bit will be set = 0 to indicate that the command byte is being written.

Acknowledge (ACK)

Acknowledge (ACK) provides a positive handshake between the host and the MC74. The host releases SDA after transmitting eight bits, then generates a ninth clock cycle to allow the MC74 to pull the SDA line LOW to acknowledge that it successfully received the previous eight bits of data or address.

Data Byte

After a successful ACK of the address byte, the host must transmit the data byte to be written or clock out the data to be read. (See the appropriate timing diagrams.) ACK will be generated after a successful write of a data byte into the MC74.

Stop Condition (STOP)

Communications must be terminated by a stop condition (a LOW to HIGH transition of SDA while SCL is HIGH). The Stop Condition must be communicated by the transmitter to the MC74. NOTE: Refer to Timing Diagrams for serial bus timing (Figure 2).

SMBUS Write Timing Diagram

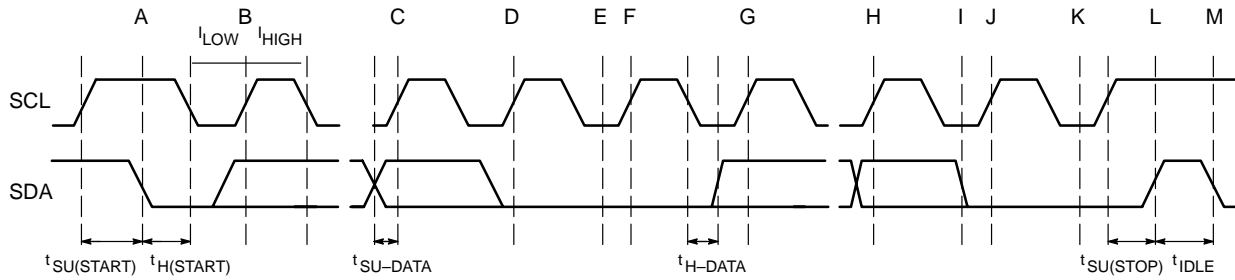

- | | | |
|---------------------------------------|---|--|
| A = Start Condition | F = Acknowledge Bit Clocked into Master | J = Acknowledge Clocked into Master |
| B = MSB of Address Clocked into Slave | G = MSB of Data Clocked into Slave | K = Acknowledge Clock Pulse |
| C = LSB of Address Clocked into Slave | H = LSB of Data Clocked into Slave | L = Stop Condition, Data Executed by Slave |
| D = R/W Bit Clocked into Slave | I = Slave Pulls SDA Line Low | M = New Start Condition |
| E = Slave Pulls SDA Line Low | | |

SMBUS Read Timing Diagram

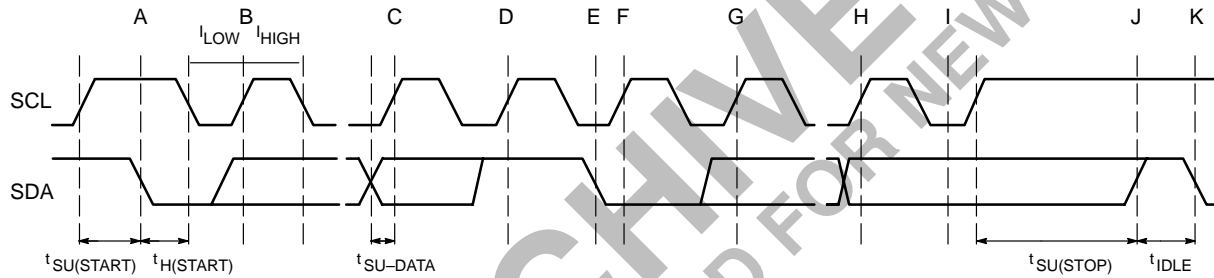

- | | | |
|---------------------------------------|---|-----------------------------|
| A = Start Condition | E = Slave Pulls SDA Line Low | I = Acknowledge Clock Pulse |
| B = MSB of Address Clocked into Slave | F = Acknowledge Bit Clocked into Master | J = Stop Condition |
| C = LSB of Address Clocked into Slave | G = MSB of Data Clocked into Master | K = New Start Condition |
| D = R/W Bit Clocked into Slave | H = LSB of Data Clocked into Master | |

Figure 2. Timing Diagrams

REGISTER SET and PROGRAMMER'S MODEL

MC74 Command Set
(SMBus READ_BYTE and WRITE_BYTE)

Command Byte Description

Command	Code	Function
RTR	00h	Read Temperature (TEMP)
RWCR	01h	Read/Write Configuration (CONFIG)

Configuration Register (CONFIG), 8-BITS,
READ/WRITE

Configuration Register (Config)

D[7]	D[6]	D[5]	D[4]	D[3]	D[2]	D[1]	D[0]
SHDN	Data Rdy	Reserved					

Bit	POR	Function	Type	Operation
D[7]	0	STANDBY switch	Read/Write	1 = stand-by, 0 = normal
D[6]	0	Data Ready*	Read Only	1 = ready, 0 = not ready
D[5]–D[0]	0	Reserved – Always returns zero when read.	N/A	N/A

*DATA_RDY bit reset at power-up and SHDN enable (see below).

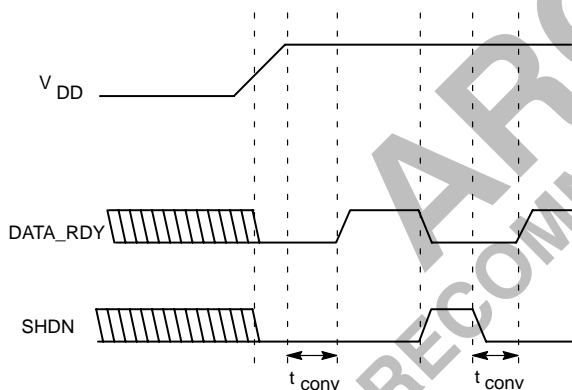

Figure 3. DATA_RDY, SHDN Operation Logic Diagram

Temperature Register (TEMP), 8-Bits,
READ-ONLY

The binary value (2's complement format) in this register represents temperature of the integrated sensor following a conversion cycle. The registers are automatically updated in an alternating manner.

Temperature Register (TEMP)

D[7]	D[6]	D[5]	D[4]	D[3]	D[2]	D[1]	D[0]
MSB	x	x	x	x	x	x	LSB

In the temperature data registers, each unit value represents one degree (Celsius). The value is in 2's-complement binary format such that a reading of 0000 0000b corresponds to 0°C. Examples of this temperature to binary value relationship are shown in the following table.

Temperature-to-Digital Value Conversion (TEMP)

ACTUAL TEMPERATURE	REGISTERED TEMPERATURE	BINARY HEX
+130.00°C	+127°C	0111 1111
+127.00°C	+127°C	0111 1111
+126.50°C	+127°C	0111 1111
+25.25°C	+25°C	0001 1001
+0.50°C	+1°C	0000 0001
+0.25°C	0°C	0000 0000
0.00°C	0°C	0000 0000
-0.25°C	0°C	0000 0000
-0.50°C	0°C	0000 0000
-0.75°C	-1°C	1111 1111
-1.00°C	-1°C	1111 1111
-25.00°C	-25°C	1110 0111
-25.25°C	-25°C	1110 0110
-54.75°C	-55°C	1100 1001
-55.00°C	-55°C	1100 1001
-65.00°C	-65°C	1011 1111

Register Set Summary

The MC74's register set is summarized below. All registers are 8-bits wide.

Name	Description	POR State	Read	Write
TEMP	Internal sensor temperature (2's complement)	0000 0000b*	√	
CONFIG	CONFIG register	0000 0000b	√	√

*NOTE: The TEMP register immediately will be updated by the A/D converter after the DATA_RDY bit goes high.

TAPING FORM

Component Taping Orientation for 5L SOT-23 Devices

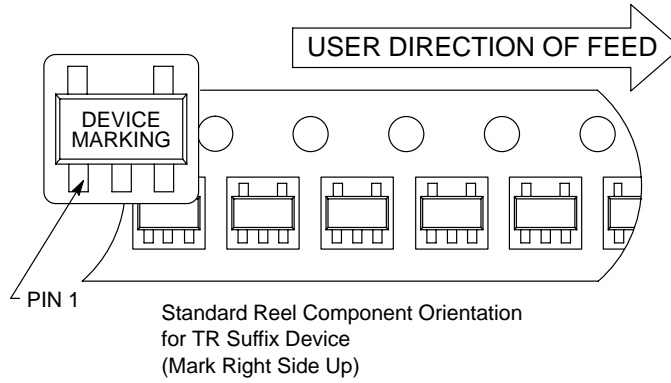

Tape & Reel Specifications Table

Package	Tape Width (W)	Pitch (P)	Part Per Full Reel	Diameter
5L SOT-23A	8 mm	4 mm	3000	7 inches

ARCHIVE

DEVICE NOT RECOMMENDED FOR NEW DESIGN

MC74

ORDERING INFORMATION AND DEVICE MARKINGS

Device	Marking (xx)	Package	Voltage	Address	Shipping
MC74A0-3.3SNTR	V0	SOT-23A-5	3.3 V V _{DD}	1001 000	3000 Units / Tape & Reel
MC74A1-3.3SNTR	V1			1001 001	
MC74A2-3.3SNTR	V2			1001 010	
MC74A3-3.3SNTR	V3			1001 011	
MC74A4-3.3SNTR	V4			1001 100	
MC74A5-3.3SNTR*	V5			1001 101	
MC74A6-3.3SNTR	V6			1001 110	
MC74A7-3.3SNTR	V7			1001 111	
MC74A0-5.0SNTR	U0	SOT-23A-5	5.0 V V _{DD}	1001 000	3000 Units / Tape & Reel
MC74A1-5.0SNTR	U1			1001 001	
MC74A2-5.0SNTR	U2			1001 010	
MC74A3-5.0SNTR	U3			1001 011	
MC74A4-5.0SNTR	U4			1001 100	
MC74A5-5.0SNTR*	U5			1001 101	
MC74A6-5.0SNTR	U6			1001 110	
MC74A7-5.0SNTR	U7			1001 111	
MC74A0-3.3T	V0	TO-220-5	3.3 V V _{DD}	1001 000	3000 Units / Tape & Reel
MC74A1-3.3T	V1			1001 001	
MC74A2-3.3T	V2			1001 010	
MC74A3-3.3T	V3			1001 011	
MC74A4-3.3T	V4			1001 100	
MC74A5-3.3T	V5			1001 101	
MC74A6-3.3T	V6			1001 110	
MC74A7-3.3T	V7			1001 111	
MC74A0-5.0T	U0	TO-220-5	5.0 V V _{DD}	1001 000	3000 Units / Tape & Reel
MC74A1-5.0T	U1			1001 001	
MC74A2-5.0T	U2			1001 010	
MC74A3-5.0T	U3			1001 011	
MC74A4-5.0T	U4			1001 100	
MC74A5-5.0T*	U5			1001 101	
MC74A6-5.0T	U6			1001 110	
MC74A7-5.0T	U7			1001 111	

*Default voltages and addresses. Contact your ON Semiconductor sales representative for other voltage and address options.

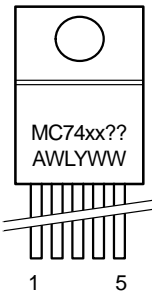
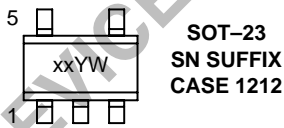

xx = Specific Device Code
 A = Assembly Location
 WL, L = Wafer Lot
 Y = Year
 WW = Work Week

MC74

PACKAGE DIMENSIONS

TO-220
T SUFFIX
CASE 314D-04
ISSUE E

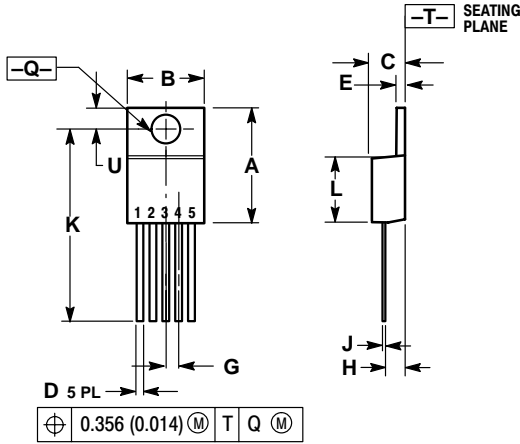

NOTES:

1. DIMENSIONING AND TOLERANCING PER ANSI Y14.5M, 1982.
2. CONTROLLING DIMENSION: INCH.
3. DIMENSION D DOES NOT INCLUDE INTERCONNECT BAR (DAMBAR) PROTRUSION. DIMENSION D INCLUDING PROTRUSION SHALL NOT EXCEED 10.92 (0.043) MAXIMUM.

DIM	INCHES		MILLIMETERS	
	MIN	MAX	MIN	MAX
A	0.572	0.613	14.529	15.570
B	0.390	0.415	9.906	10.541
C	0.170	0.180	4.318	4.572
D	0.025	0.038	0.635	0.965
E	0.048	0.055	1.219	1.397
G	0.067 BSC		1.702 BSC	
H	0.087	0.112	2.210	2.845
J	0.015	0.025	0.381	0.635
K	0.990	1.045	25.146	26.543
L	0.320	0.365	8.128	9.271
Q	0.140	0.153	3.556	3.886
U	0.105	0.117	2.667	2.972

SOT-23
SN SUFFIX
CASE 1212-01
ISSUE O

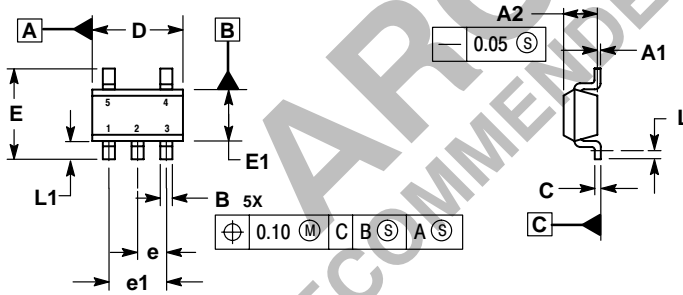

NOTES:

1. DIMENSIONS ARE IN MILLIMETERS.
2. INTERPRET DIMENSIONS AND TOLERANCES PER ASME Y14.5M, 1994.
3. DATUM C IS A SEATING PLANE.

DIM	MILLIMETERS	
	MIN	MAX
A1	0.00	0.10
A2	1.00	1.30
B	0.30	0.50
C	0.10	0.25
D	2.80	3.00
E	2.50	3.10
E1	1.50	1.80
e	0.95 BSC	
e1	1.90 BSC	
L	0.20	---
L1	0.45	0.75

Notes

ARCHIVE
DEVICE NOT RECOMMENDED FOR NEW DESIGN

ON Semiconductor and  are trademarks of Semiconductor Components Industries, LLC (SCILLC). SCILLC reserves the right to make changes without further notice to any products herein. SCILLC makes no warranty, representation or guarantee regarding the suitability of its products for any particular purpose, nor does SCILLC assume any liability arising out of the application or use of any product or circuit, and specifically disclaims any and all liability, including without limitation special, consequential or incidental damages. "Typical" parameters which may be provided in SCILLC data sheets and/or specifications can and do vary in different applications and actual performance may vary over time. All operating parameters, including "Typicals" must be validated for each customer application by customer's technical experts. SCILLC does not convey any license under its patent rights nor the rights of others. SCILLC products are not designed, intended, or authorized for use as components in systems intended for surgical implant into the body, or other applications intended to support or sustain life, or for any other application in which the failure of the SCILLC product could create a situation where personal injury or death may occur. Should Buyer purchase or use SCILLC products for any such unintended or unauthorized application, Buyer shall indemnify and hold SCILLC and its officers, employees, subsidiaries, affiliates, and distributors harmless against all claims, costs, damages, and expenses, and reasonable attorney fees arising out of, directly or indirectly, any claim of personal injury or death associated with such unintended or unauthorized use, even if such claim alleges that SCILLC was negligent regarding the design or manufacture of the part. SCILLC is an Equal Opportunity/Affirmative Action Employer.

PUBLICATION ORDERING INFORMATION

NORTH AMERICA Literature Fulfillment:

Literature Distribution Center for ON Semiconductor
 P.O. Box 5163, Denver, Colorado 80217 USA
Phone: 303-675-2175 or 800-344-3860 Toll Free USA/Canada
Fax: 303-675-2176 or 800-344-3867 Toll Free USA/Canada
Email: ONlit@hibbertco.com
 Fax Response Line: 303-675-2167 or 800-344-3810 Toll Free USA/Canada

N. American Technical Support: 800-282-9855 Toll Free USA/Canada

EUROPE: LDC for ON Semiconductor – European Support

German Phone: (+1) 303-308-7140 (Mon-Fri 2:30pm to 7:00pm CET)
Email: ONlit-german@hibbertco.com
French Phone: (+1) 303-308-7141 (Mon-Fri 2:00pm to 7:00pm CET)
Email: ONlit-french@hibbertco.com
English Phone: (+1) 303-308-7142 (Mon-Fri 12:00pm to 5:00pm GMT)
Email: ONlit@hibbertco.com

EUROPEAN TOLL-FREE ACCESS*: 00-800-4422-3781

*Available from Germany, France, Italy, UK, Ireland

CENTRAL/SOUTH AMERICA:

Spanish Phone: 303-308-7143 (Mon-Fri 8:00am to 5:00pm MST)
Email: ONlit-spanish@hibbertco.com
Toll-Free from Mexico: Dial 01-800-288-2872 for Access –
 then Dial 866-297-9322

ASIA/PACIFIC: LDC for ON Semiconductor – Asia Support

Phone: 303-675-2121 (Tue-Fri 9:00am to 1:00pm, Hong Kong Time)
Toll Free from Hong Kong & Singapore:
001-800-4422-3781
Email: ONlit-asia@hibbertco.com

JAPAN: ON Semiconductor, Japan Customer Focus Center

4-32-1 Nishi-Gotanda, Shinagawa-ku, Tokyo, Japan 141-0031
Phone: 81-3-5740-2700
Email: r14525@onsemi.com

ON Semiconductor Website: <http://onsemi.com>

For additional information, please contact your local Sales Representative.